

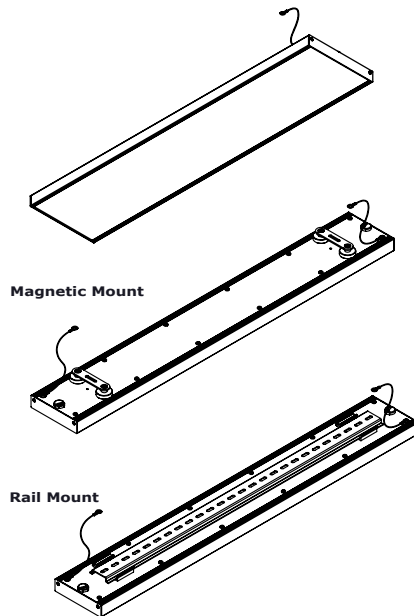

DATASHEET

LUCIAN Cove Blade 90

High output surface mounted ultra-thin 90mm wide light panel, cove blade is the perfect fixture for cove lighting. This Low glare LED panel provides direct and soft light delivery for an efficient and shadow-free cove solution that is easy to install for the builder. The Cove Blade system eliminates the need for complex construction details and is designed to work with a simple square edge cavity. Comes with a wide range of outputs and colour temperature options. 0-10v and Dali dimming options available.

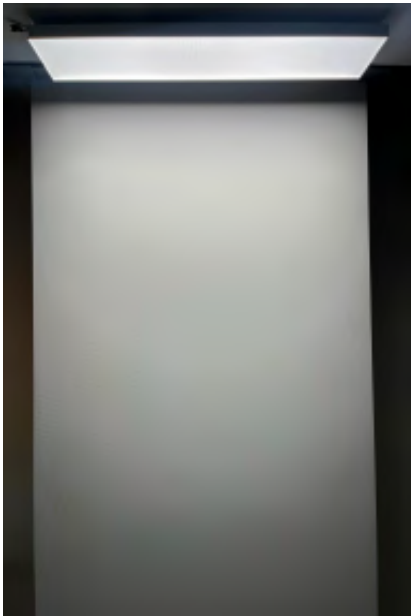

Rail Mount

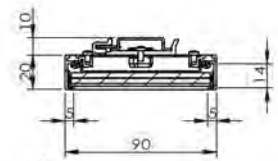

Magnetic Mount

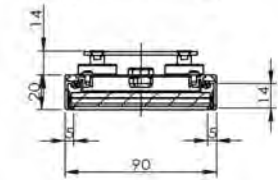

90mm Width

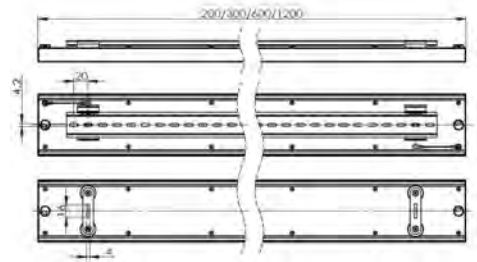

DIMENSIONS

WIDTH	HEIGHT	LENGTH
90mm	30/34mm	from 200 to max 2000mm in a single piece

TECHNICAL

Life maintenance	L90 50.000h
Output	10W/m-923lm, 15W/m-1385lm, 20W/m-1846lm, 30W/m 2770lm
CRI	>90
IP	IP20 or IP44
Optic	Opal or Microprismatic
Mounting Accessories	Via Magnets or Rail
Input	24V-Remote driver

CODE BUILDER

Model	Finish	CT	Optic	Led	CRI	Mounting	Dimming	IP	Length
CB90	W-white	2700K	Opal	10W/m	>90	Magnets	non dim	IP20	
	B-black	3000K	Micro	15W/m		Rail	1-10V	IP44	
		4000K		20W/m			Dali		
		TW		30W/m					
		RGBW							

WHY USE COVE BLADE

CONVENTIONAL COVE DETAIL

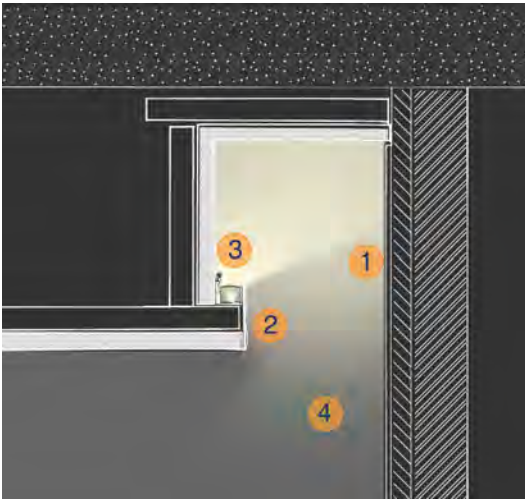

1. Visible shadowing on wall
2. Complex detailing which creates construction issues and additional costs for trades
3. Difficult cable reticulation, potential for visibility. Messy mounting detail
4. Low efficiency light output which relies on reflection. Limited illumination of wall below. Poor colour consistency due to cove finishes

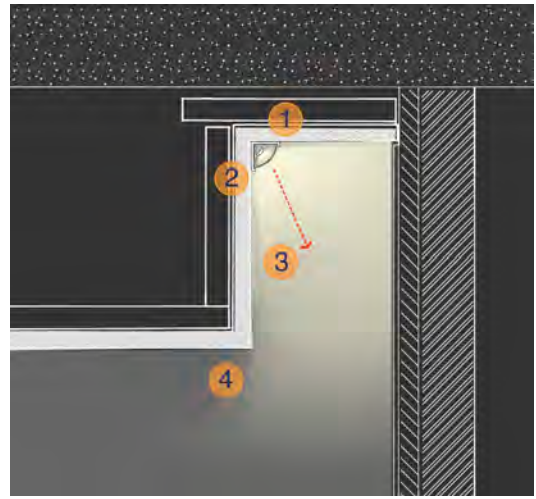

1. Difficult mounting detail in deeper coves
2. Limited opportunity for concealment of cables
3. Narrow angle of light creates harsh shadowing which could highlight wall inconsistencies in particular plaster joints and tiled walls
4. Harsh shadowing effect on wall and floor

COVE BLADE DETAIL



1. Plenty of room to conceal cabling. Easy installation via magnetic brackets
2. Simple cove construction without complex & costly detailing
3. Softer delivery of light limits shadowing. Higher efficiency via more direct output. More effective illumination of wall. More consistent colour of light (no reliance on cove finish).

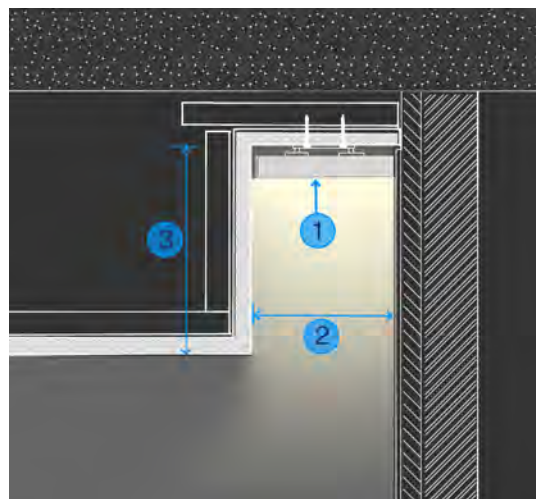

1. 90mm & 140mm standard sizes
2. For 100 & 150mm wide coves, custom sizes on request
3. Flexible depth dimensions, ideal 1.5/2x width for optimal efficiency vs concealment